

リユースバンド
RE-USE BAND / RSG



着脱かんたん
リユーススナップ
Detachable snap

スナップ固定式リユースタイプの結束バンド

Releasable snap-mount band that allows for easy access and maintenance of cables

特長 Features

- 束線部、スナップ部とも取り外し可能でメンテナンスや分解時の作業性に優れています。
- Detachable snap and un-lockable band allow easy maintenance and disassembling.



材料 Material

- ナイロン66 (色調: ブラック / RSG-150E-BK, -190E-BK)
- ナイロン66 (色調: ナチュラル / RSG-100 V0, -130 V0, -80E-V0)
- Nylon66 (Color: Black / RSG-150E-BK, -190E-BK)
- Nylon66 (Color: Natural / RSG-100 V0, -130 V0, -80E-V0)

UL94 V-2

UL94 V-0

RSG-100 V0,130-V0

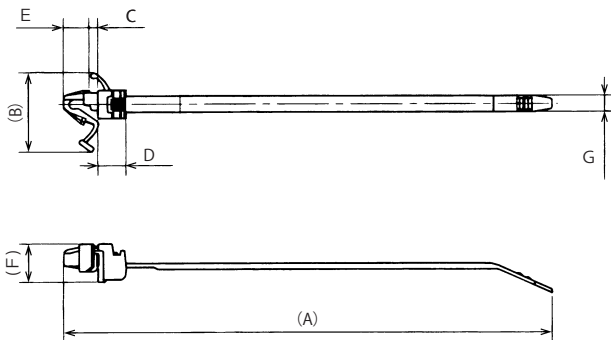

RSG-80E-V0

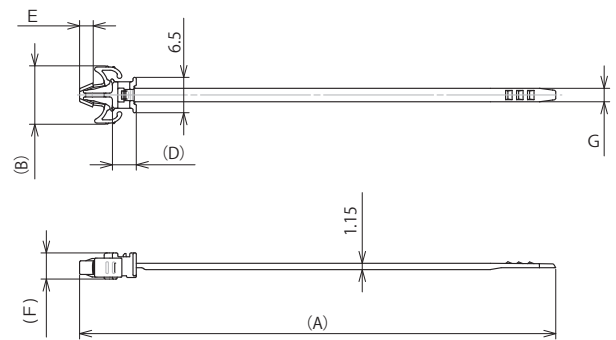

RSG-150E-BK

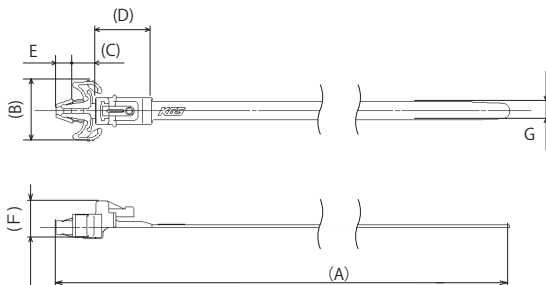

RSG-190E-BK

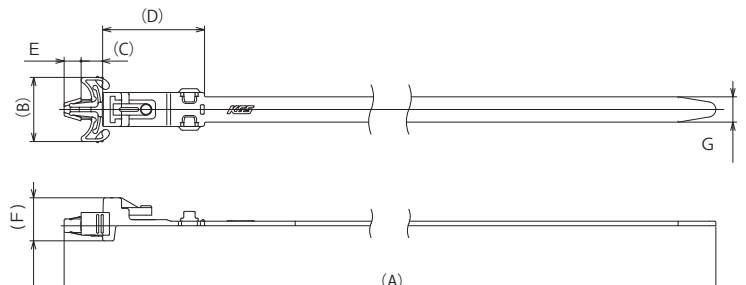

スナップ取外し
Snap removal

結束取外し
Bundle release

余長処理
Holding remaining part

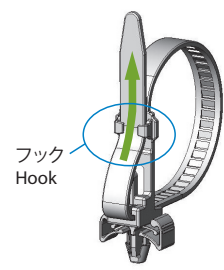
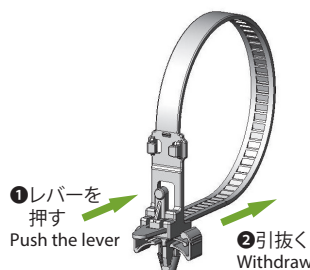
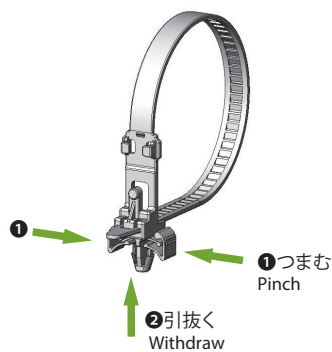

※RSG-190E-BKのみ
※RSG-190E-BK only

	品番 Part No.	(A)	(B)	(C)	(D)	E	(F)	G	取付孔 Mounting hole size	取付板厚 Panel thickness	束線径 Bundle diameter	包装単位 Std. Package
UL	RSG-100 V0	100.0	16.2	1.8	5.9	5.2	7.3	3.3	φ4.8 ^{+0.2}	0.5~1.6	φ1~20	500本 / pcs.
UL	RSG-130-V0	133.5	17.9	2.7	6.2	5.2	7.3	3.3		0.6~2.4	φ1~24	
	RSG-150E-BK	149.3	16.0	5.9	15.0	4.4	9.5	4.7		0.5~2.3	φ7~30	100本 / pcs.
	RSG-190E-BK	195.2	17.0	5.7	27.0	4.5	11.4	6.7	0.5~2.3	φ10~47		
UL	RSG-80E-V0	87.4	10.7	—	4.4	4.4	4.8	2.5	φ3.5 ^{+0.2} _{-0.05}	0.5~1.6	φ1~15	1,000本 / pcs.

UL ...UL62275 取得品 / UL62275 recognized product (単位 / Unit : mm)